

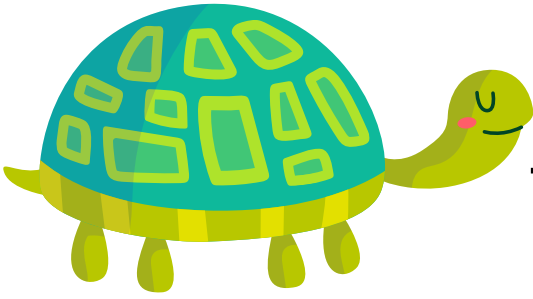

कलश
(Urn)

कमल
(Lotus)



कछुआ
(Tortoise)



कबूतर
(Pigeon)

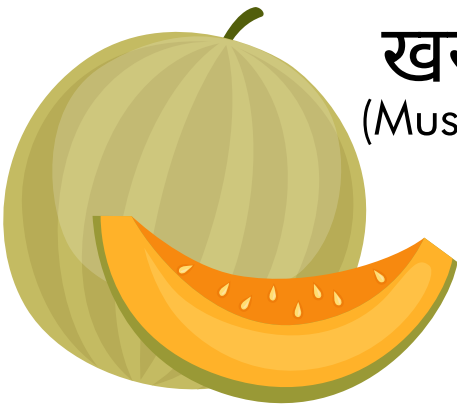

खरबूजा
(Muskmelon)

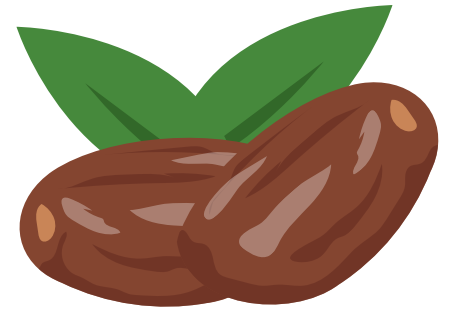

खजूर
(Dates)

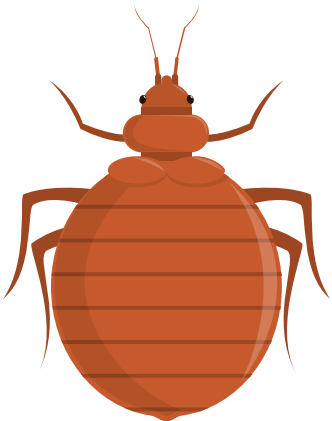

खटमल
(Bedbug)

खरगोश
(Rabbit)

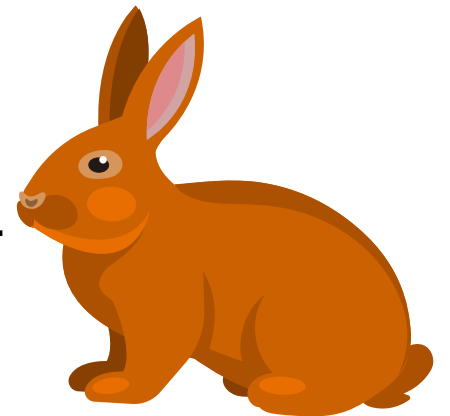



गमला
(Flower-pot)

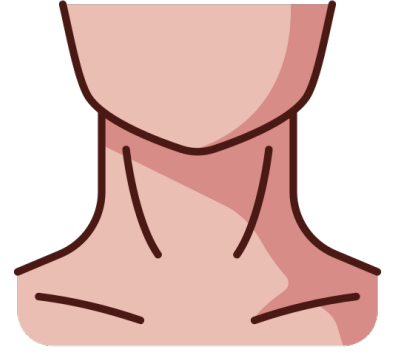

गरदन
(Neck)

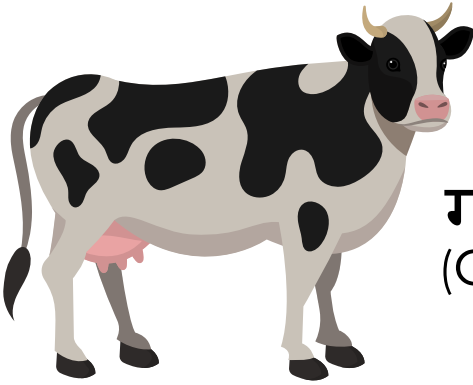

गाय
(Cow)

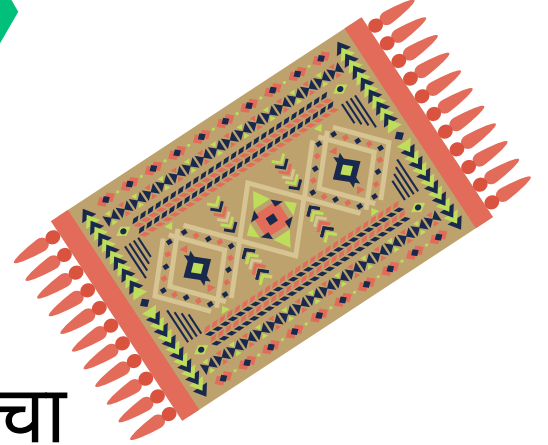

गलीचा
(Carpet)



घडी
(Watch)

घर
(House)

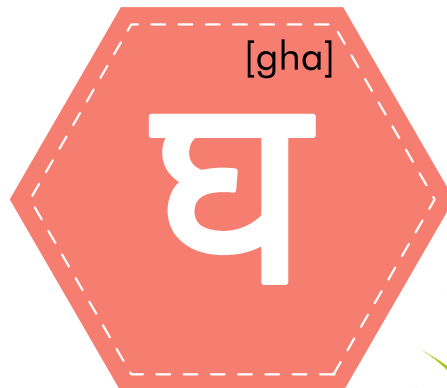

घंटा
(Bell)



घास
(Grass)



चमेली
(Jasmine)

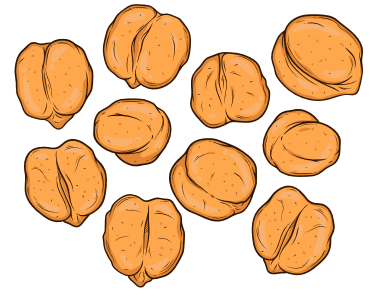

चना
(Chickpeas)



चमगादड़
(Bat)

चम्मच
(Spoon)



छत्ता
(Hive)



छतरी
(Umbrella)

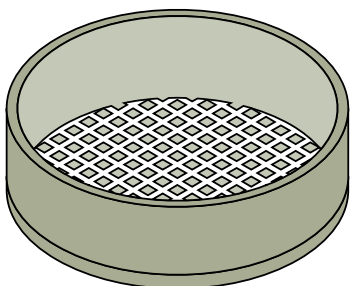

छलनी
(Strainer)

छड़ी
(Stick)

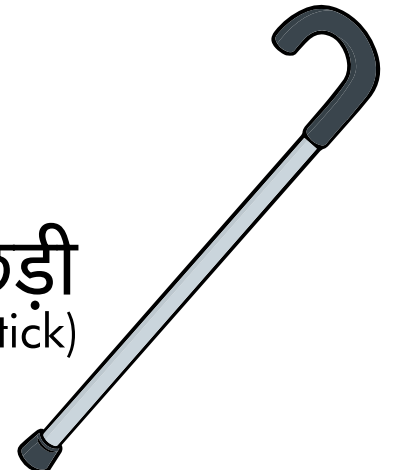

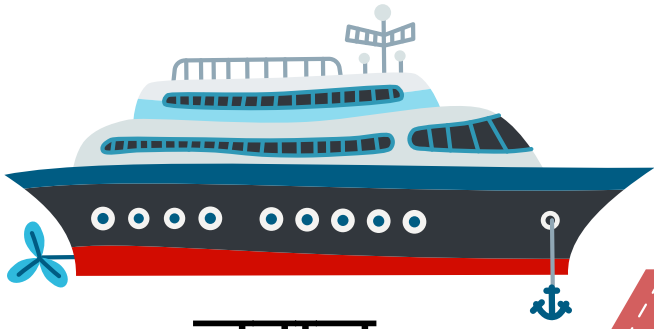

जहाज
(Ship)

जल
(Water)



जलेबी
(Jalebi)

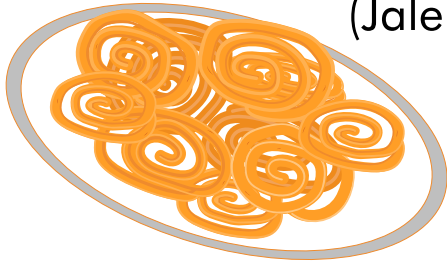

जग
(Jug)



झंडा
(Flag)

झरना
(Waterfall)



झरोखा
(Window)

झुला
(Swing)

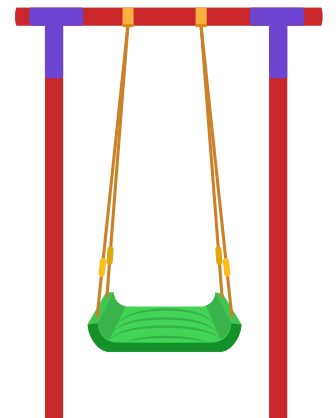



टमाटर
(Tomato)



टब
(Tab)

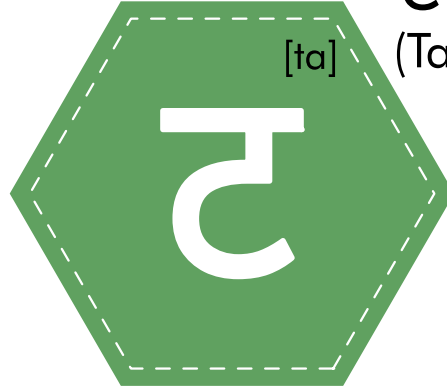

टायर
(Swing)



टहनी
(Twig)



ठंडा
(Cold)

ठप्पा
(Stamp)



ठेला
(Cart)



ठग
(Cheater)



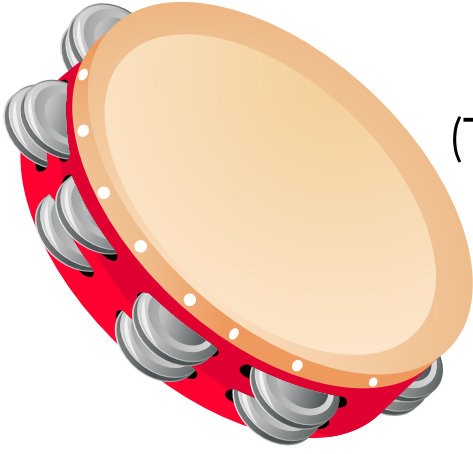

डफली
(Tambourine)

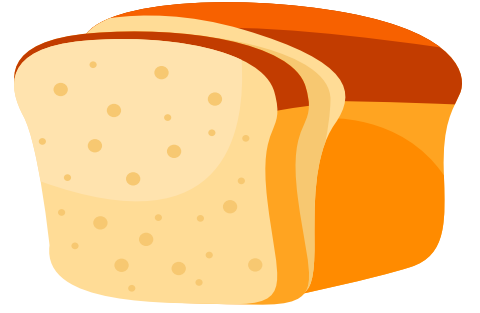

डबल-रोटी
(Bread)



डब्बा
(Container)



डमरू
(Pellet drum)



ढक्कन
(Cover/Cap)

ढोकला
(Dhokla)

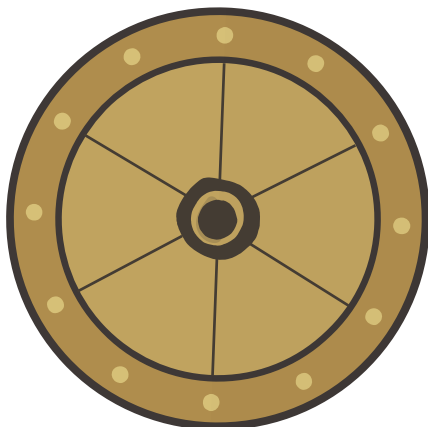
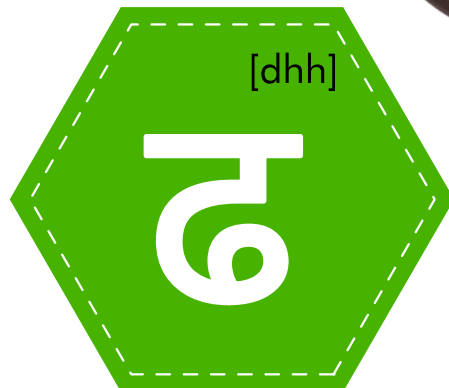

ढाल
(Shield)

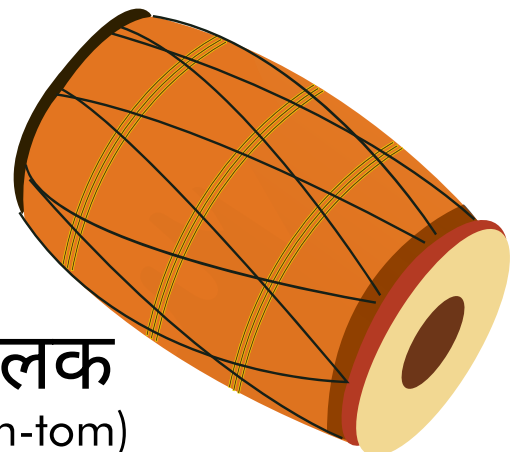

ढोलक
(Tom-tom)



रावण
(Ravan)



बाण
(Arrow)

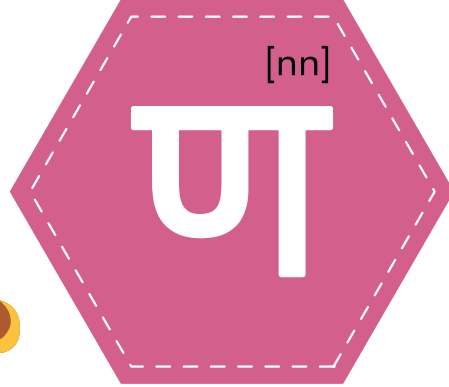

वीणा
(Veena)

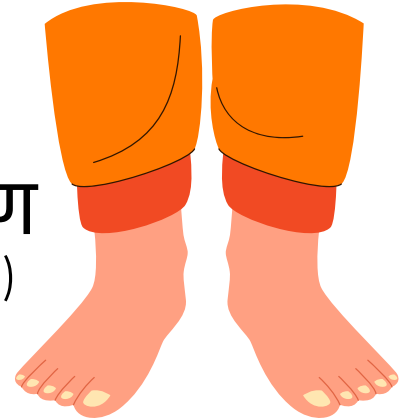

चरण
(Leg)



तकिया
(Pillow)

तबला
(Tabala)

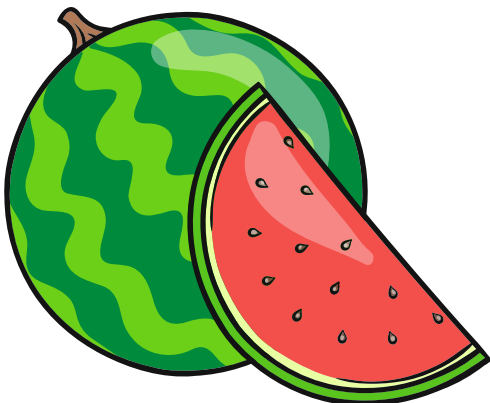
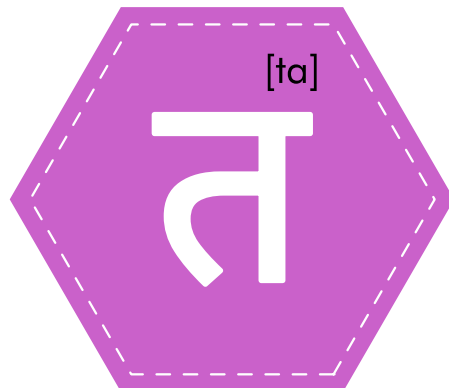

तरबूज
(Watermelon)



तलवार
(Sword)

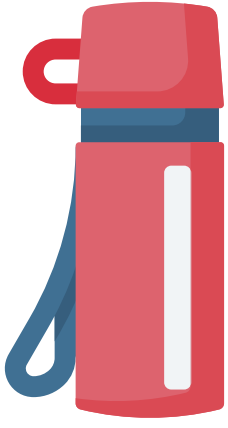

थर्मस
(Thermos)

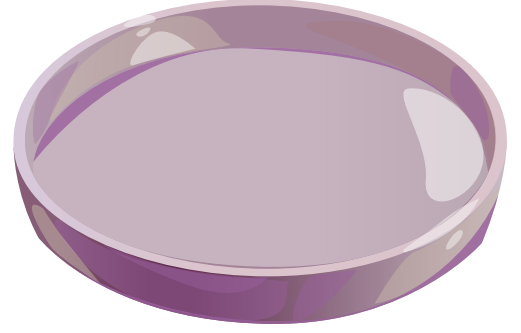

थाली
(Plate)



थेपला
(Thepla)

थर्मामीटर
(Thermometer)



दवाई
(Medicine)

दस्ताने
(Gloves)

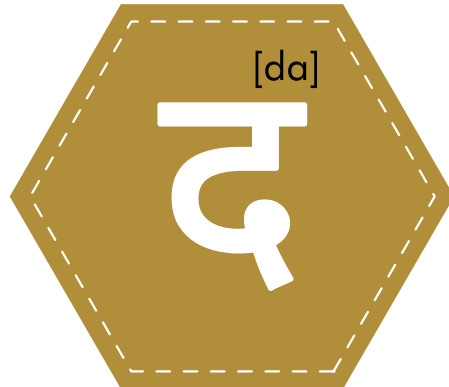

दवात
(Ink)

दरवाज़ा
(Gate)





धन
(Wealth)

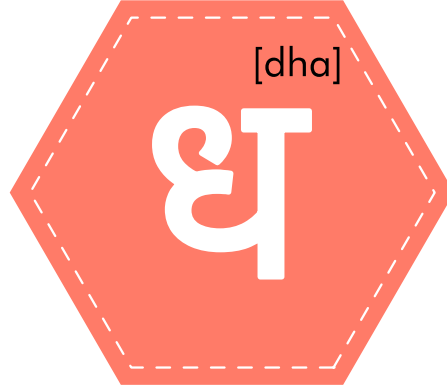

धनिया
(Coriander)

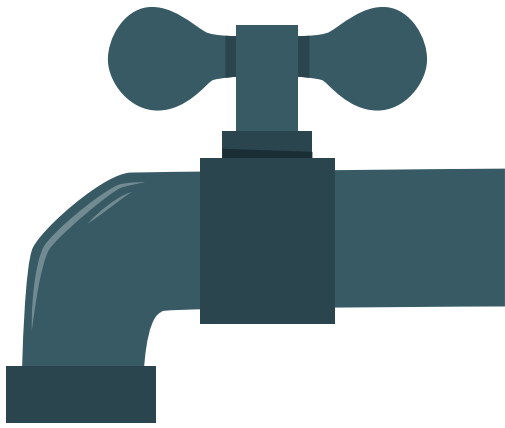

नल
(Tap)

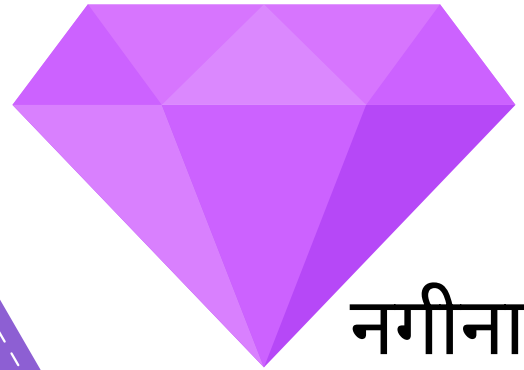

नगीना
(Diamond)

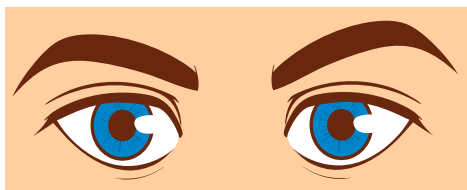
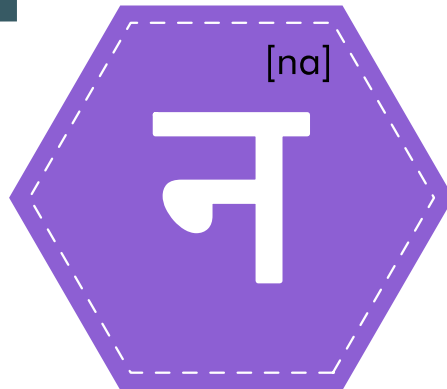

नकाब
(Mask)



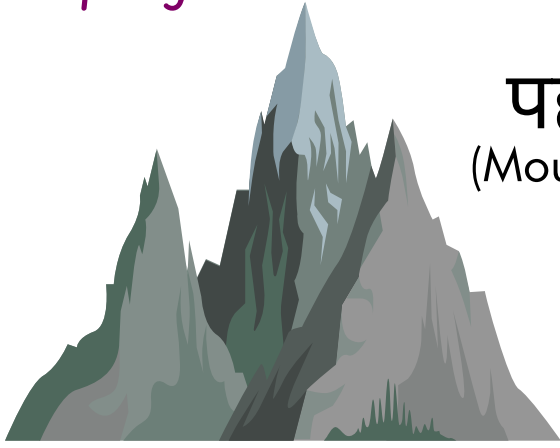

पहाड़
(Mountain)

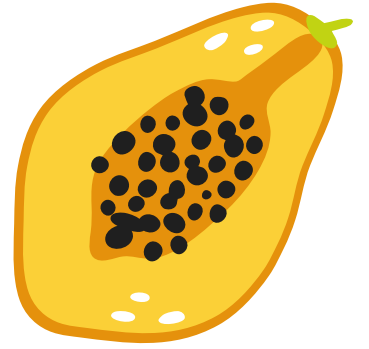

पपीता
(Papaya)

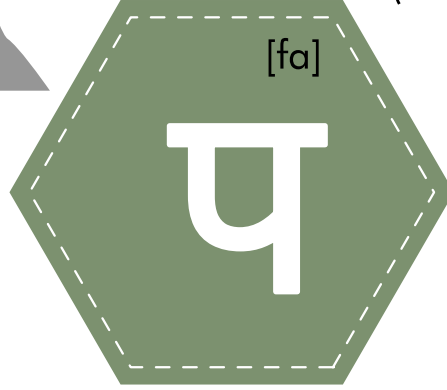

परिवार
(Family)



पतंग
(Kite)



फल
(Fruit)



फरसा
(Axe)



फन
(Faan)



फव्वारा
(Fountain)

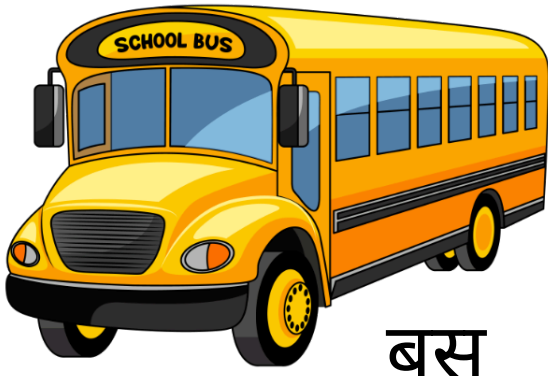

बस
(Bus)

बतख
(Duck)

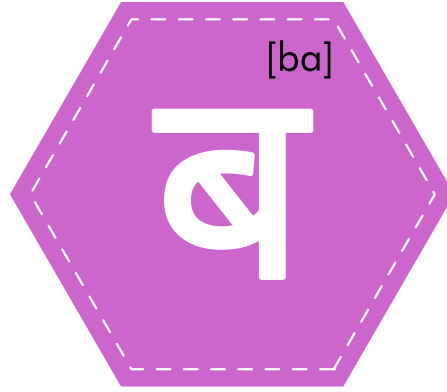
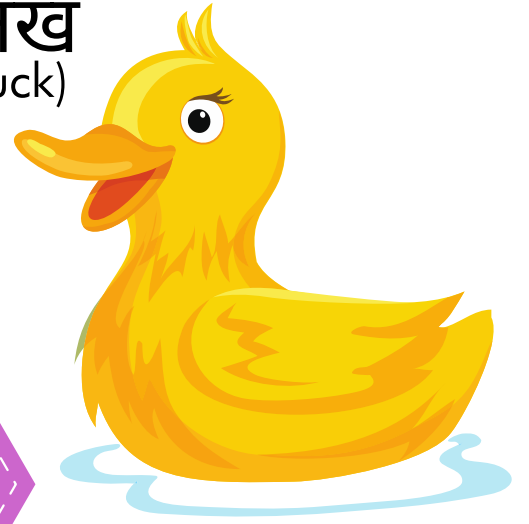

बरतन
(Vessel)



बटन
(Button)



भगत
(Bhagat)

भस्म
(Ashes)



भंवरा
(Bee)

भगोना
(Stir pot)





मकड़ी
(Spider)

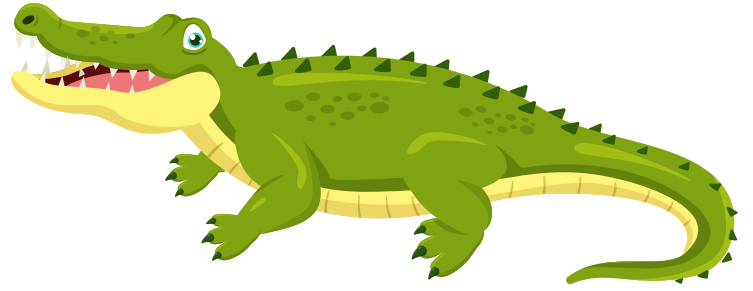

मगर
(Crocodile)

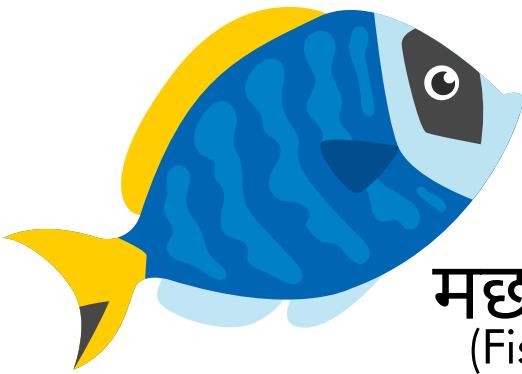
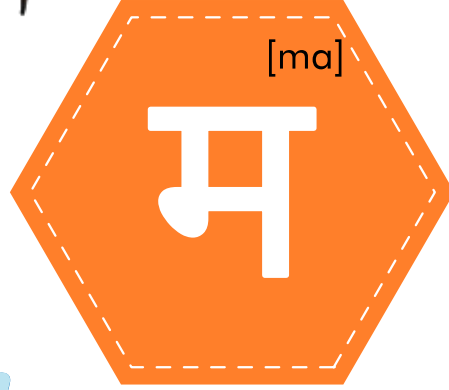

मछली
(Fish)

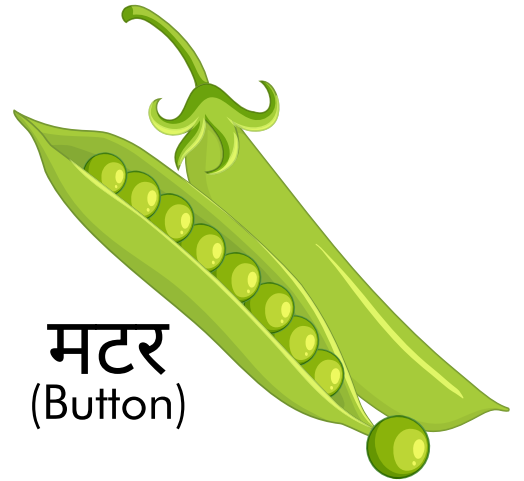

मटर
(Button)



यज्ञ
(Yagyn)



यमराज
(Yamraj)

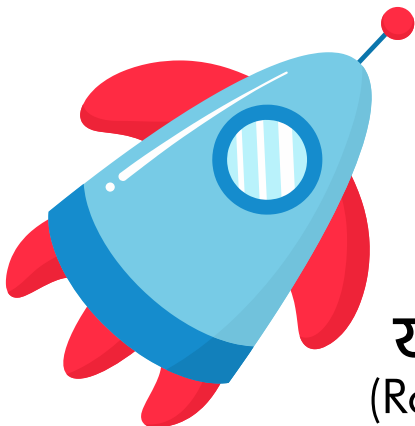

यान
(Rocket)

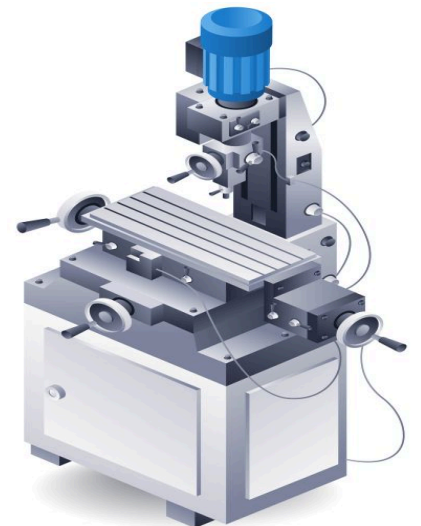

यंत्र
(Machine)

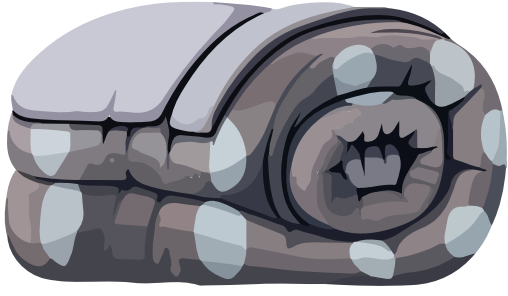

रजाई
(Blanket)



रस्सी
(Rope)

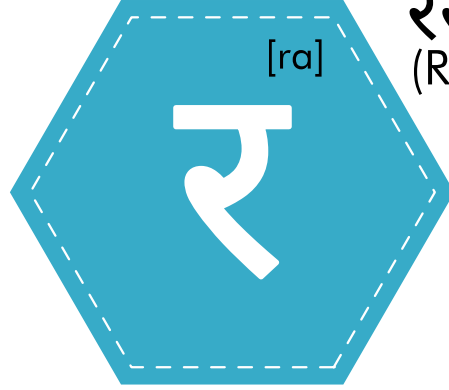

रसमलाई
(Ras-Malai)



रुई
(Cotton)



लट्टू
(Top)

लहसुन
(Garlic)

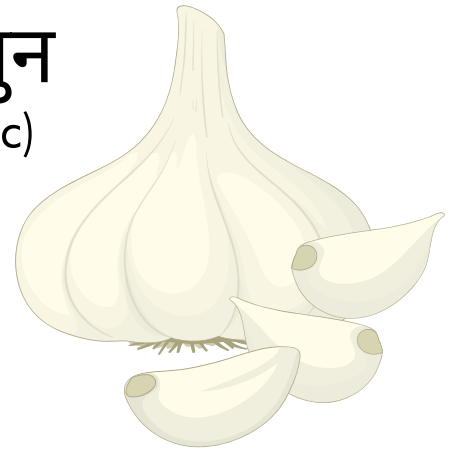

लड़की
(Girl)



लकड़ी
(Wood)



वजन
(Weight)



वकील
(Advocate)

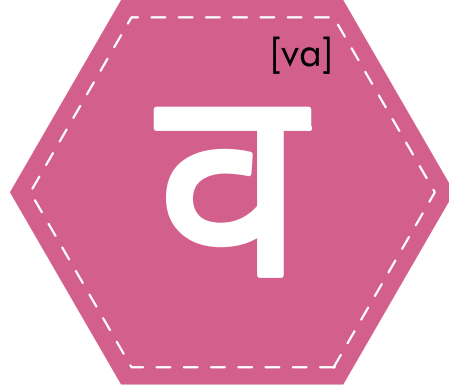

वर्दी
(Uniform)



वस्त्र
(Clothes)



शहनाई
(Clarinet)



शहद
(Honey)

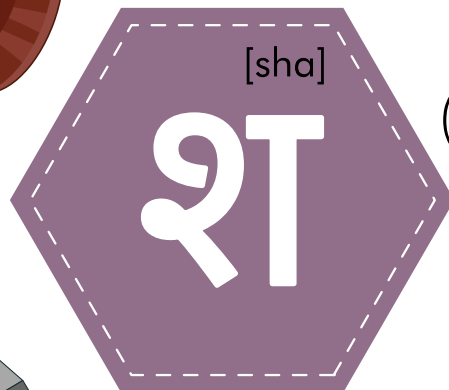

शतरंज
(Chess)

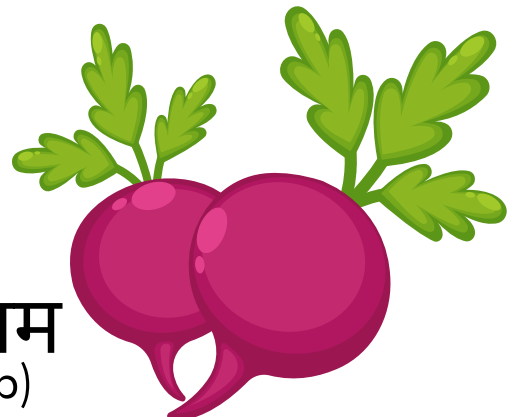

शलजम
(Turnip)

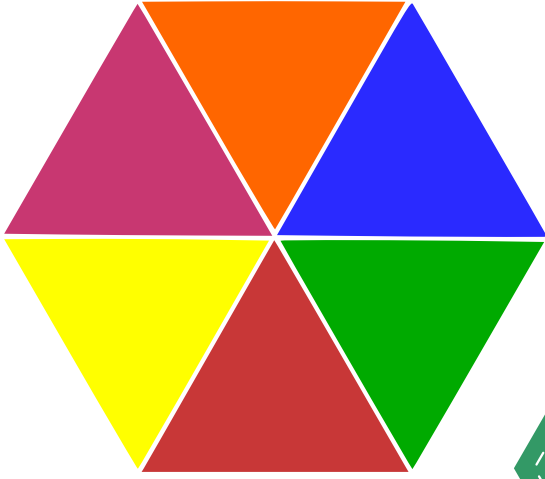

षटकोण
(Hexagon)

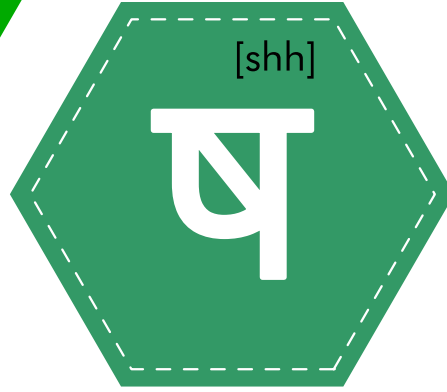

षष्ट
(Six)

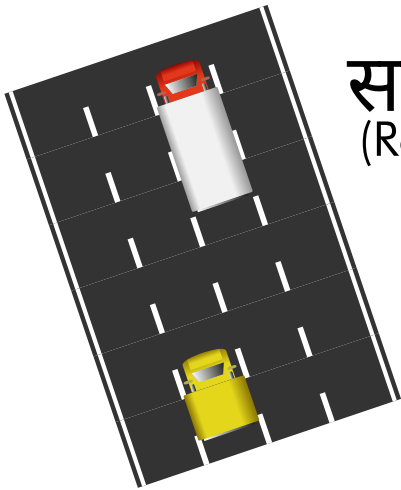
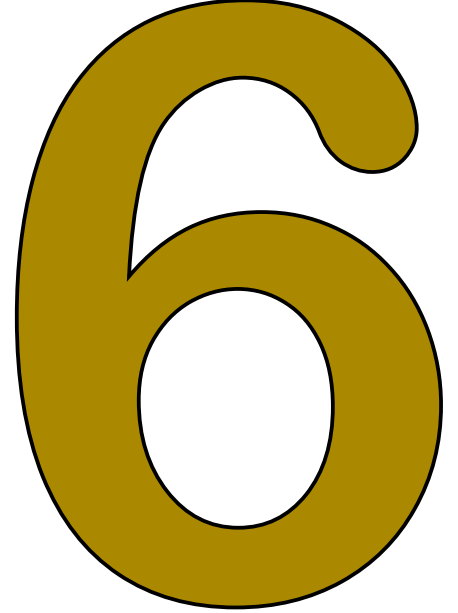

सड़क
(Road)

सपेरा
(Snake charmer)



संतरा
(Orange)

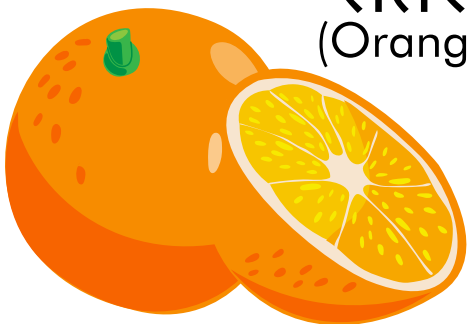

सब्जी
(Vegetable)



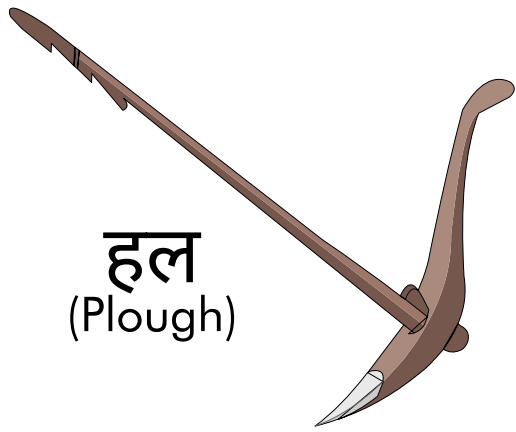

हल
(Plough)

हथेली
(Palm)



हथोड़ा
(Hammer)

हल्दी
(Turmeric)



क्षमा
(Kshama)



क्षति
(Damage)

क्षत्रिय
(Warrior)

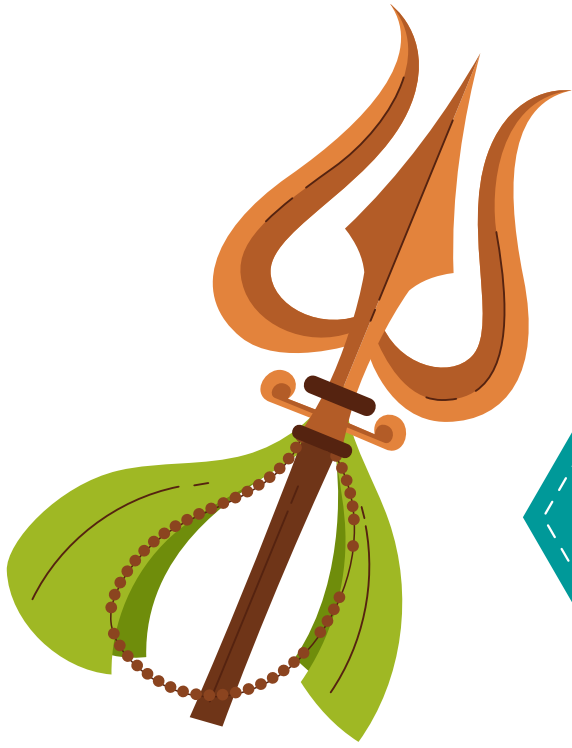

त्रिशूल
(Trishul)



त्रिदेव
(Tridev)

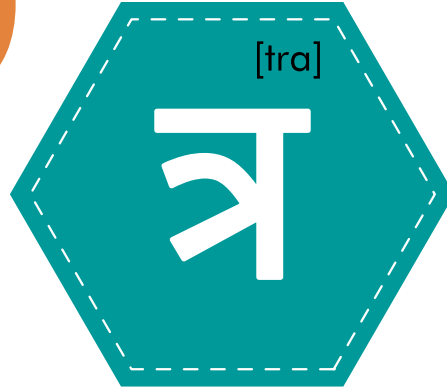

त्रिकोण
(Triangle)

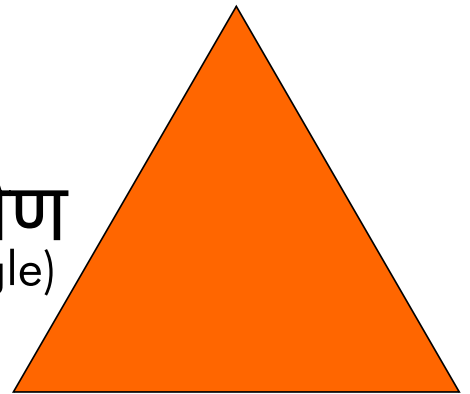

ज्ञानकोष
(GyanKosh)



ज्ञानेंद्रिया
(Sense organs)



ज्ञानालय
(University)





श्रीफल
(Coconut)

श्रमिक
(Worker)



श्रीमान
(Mister)



Download Free Worksheets